



Ventilation fan for panel boards (power saving/long lifetime type) PF-E type



Thank you for choosing our product. Please read this manual carefully before use.
Please make sure that you will not lose this manual.

Safety Instructions





It explains precautions it for use the product correctly. Please be sure to observe.
Electrical work shall performed by qualified personnel.



 WARNING	Indicates that a dangerous situation will arise which, may lead to death or severe personal injury.
 CAUTION	Indicates that property damage may result or a dangerous situation will arise which, may lead to minor to medium personal injury.

Instructions are labeled by the following symbols depending on how to deal with.





-  Should heed.
-  Must not do.
-  Must do.

Caution for construction

 WARNING	
 Do not disassemble, modify, or perform secondary operations on the product. Otherwise, malfunction, electric shock, or injury may result.	
 Be sure to ground the product. Otherwise, electric shock may result.	
 Electrical work (installation and construction) must be performed by a skilled person. Otherwise, malfunction, electric shock, or injury may result.	
Electrical work must strictly comply with the "Technical Standard for Electrical Equipment" and the "Interior Wiring Code" and the power source circuit must be a dedicated one. Otherwise, malfunction, electric shock, or injury may result.	
Select and install a leakage circuit breaker (current sensitivity of 30 mA or less) suitable for the used wire size for the power source. Otherwise, electric shock may result.	
To prevent wires from getting caught in the fan, secure them with cable ties or other means. Otherwise, malfunction or electric shock may result.	
Use compatible wires, crimp terminals, and crimping tools for wiring. Otherwise, there is a risk of heating and a fire.	

 CAUTION									
 Screws to be used must be those specified. When mounting, use the proper tightening torque. Insufficient tightening may lead to falling or damages. If tightened excessively, it may damage the product.	<table border="1" style="width: 100%; border-collapse: collapse;"> <thead> <tr> <th>Nominal size of screws</th> <th>Proper tightening torque N·m</th> <th>Applied models</th> </tr> </thead> <tbody> <tr> <td>Grounding screw M4 x 6</td> <td rowspan="2" style="text-align: center;">0.78</td> <td>PF-155E-W</td> </tr> <tr> <td>Mounting screw M4 x 55/65</td> <td>PF-091E-W·PF-125E-W·PF-155E-W</td> </tr> </tbody> </table>	Nominal size of screws	Proper tightening torque N·m	Applied models	Grounding screw M4 x 6	0.78	PF-155E-W	Mounting screw M4 x 55/65	PF-091E-W·PF-125E-W·PF-155E-W
Nominal size of screws	Proper tightening torque N·m	Applied models							
Grounding screw M4 x 6	0.78	PF-155E-W							
Mounting screw M4 x 55/65		PF-091E-W·PF-125E-W·PF-155E-W							

Cautions for use

 WARNING	
 Otherwise, electric shock may result. - Do not touch the live part while power is being supplied. - When cleaning or performing maintenance and checkup, be sure to turn off the power and stop the power source. - Do not damage the wiring or apply undue stress by pulling or pinching the wiring.	
 Do not operate with wet hands. Otherwise, malfunction or electric shock may result.	
 Do not use in the following places. Otherwise, malfunction, electric shock, or fire may result. - Places with flammable gas - Places with possible leakage of flammable gas - Places where the product may come in contact with drops of water - Places outside of the operating humidity limits - Places exposed to organic solvent - Places with corrosive gas - Places with conductive dust (carbon fiber, metal powder)	
Do not use this product in places where a malfunction of the product could result in serious consequences to human life or society.	
Maintenance and checkup should be performed periodically by persons with expertise. Otherwise, malfunction, electric shock, injury, or fire may result.	
Use the product at the rated voltage. The operating voltage should be within +/-10% of the rated voltage. Make sure that the operating voltage is not exceeded even if the power source voltage fluctuates. Otherwise, malfunction, electric shock, or fire may result.	
In case of abnormality (operation stop due to lifetime expiration, burning odor, etc.), turn off the power and stop the power source. Otherwise, electric shock or fire may result.	
Periodically check that the fan rotates properly. If left when the fan is not rotating properly, heating, fire, or electric shock may result.	
Periodically check to make sure that there is no damage or looseness in terminals after a long period of use. In case of any damage, replace the terminals. In case of any looseness, tighten them with the proper tightening torque. Otherwise, heating, fire, or electric shock may result.	

⚠ CAUTION

<p style="font-size: 8px;">Caution for the rotating part</p>	<p>Injury may result.</p> <ul style="list-style-type: none"> - Do not operate the product with the finger guard removed. - Do not insert fingers or foreign objects into the rotating parts of the fan. - During maintenance and checkup (except when inspecting the fan rotation), be sure to turn off the power source and wait until the fan blades have stopped rotating. - Attach the supplied warning indicator label (caution label for rotating parts) near the fan inside the enclosure. 		<p>Do not use in the following places. Otherwise, malfunction or incorrect operation may result.</p> <ul style="list-style-type: none"> - Places out of the operating temperature limits - Places with vibration or shock - Places with a lot of salt - Places with extreme concentration of dusty or oil particles - Places with loud noises (electric/magnetic field)
	<p>Do not vibrate or shock the product, as it is a precision instrument. Otherwise, malfunction may result.</p>		<p>When performing withstanding voltage tests on the mounting enclosure, disconnect the wiring of the product. Otherwise, malfunction may result.</p> <p>Periodically check to make sure that there is no damage or looseness in mounting parts after a long period of use. In case of any damage, replace the terminals. In case of any looseness, tighten them with the proper tightening torque. Otherwise, it may lead to falling or damages.</p>

■ Name of each part

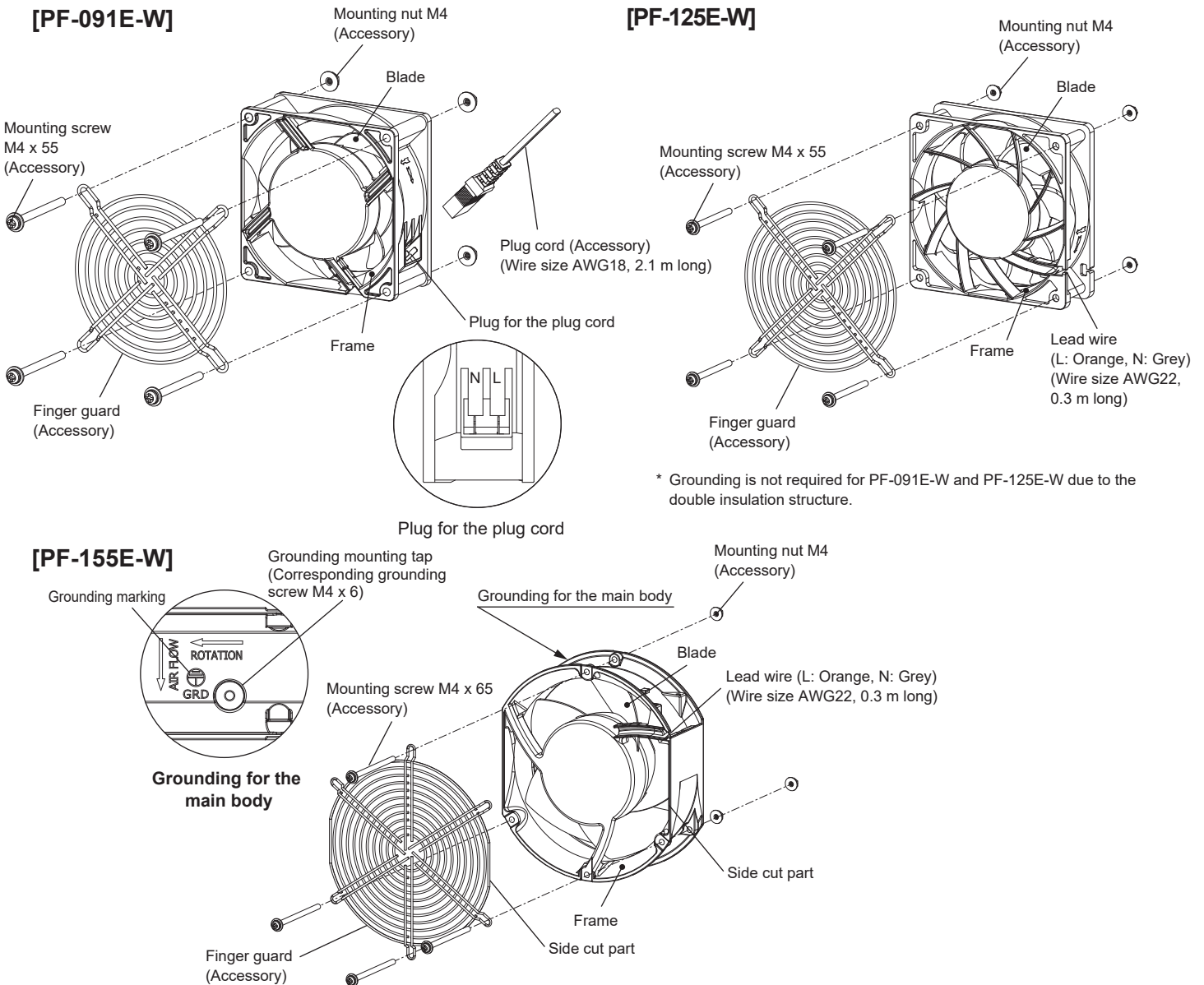

* Grounding is not required for PF-091E-W and PF-125E-W due to the double insulation structure.

● Accessory

Name	PF-091E-W	PF-125E-W	PF-155E-W
Mounting screw M4 x 55	4 pcs.	4 pcs.	—
Mounting screw M4 x 65	—	—	4 pcs.
Grounding screw M4 x 6	—	—	1 pc.
Mounting nut M4	4 pcs.	4 pcs.	4 pcs.
Plug cord (2 m)	1 pc.	—	—
Finger guard	1 pc.	1 pc.	1 pc.
Caution label for rotating parts	1 pc.	1 pc.	1 pc.
Instruction manual (Japanese)	1 copy	1 copy	1 copy
Instruction manual (English)	1 copy	1 copy	1 copy

Caution

- Mind the mounting direction of the finger guard for PF-155E-W.
Align the finger guard and the side cut part of the fan (indicated with a straight line) when mounting. If mounted in a wrong direction, mounting with four pieces of mounting screw M4 x 65 is not possible. Make sure to mount it with four pieces of mounting screw M4 x 65.

Specifications

Material: Frame is made of PBT+PC resin^{*1}, blades are made of PBT+PC resin. Operating humidity: 20 to 85 %RH, rated frequency: 50/60 Hz.

Model	Rated voltage V (single-phase)	External dimensions mm			Maximum air flow ^{2,3} m ³ /min	Maximum static pressure ^{2,3} Pa	Rated current ² A	Startup current ² A	Rated power consumption ² W	Operating temperature °C	Noise ⁴ dB(A)	Weight g	Power input terminal
		Width	Height	Depth									
PF-091E-W	AC100-240	92	92	38	1.5	90	0.08	0.8	4.5	-20 to +75	Approx. 40	250	2 terminals
PF-125E-W		120	120	38	3.9	170	0.17	1.2	9.0	-20 to +70	Approx. 52	340	Lead wire (0.3m)
PF-155E-W		150	172	51	6.7	195	0.3	3	17		Approx. 54	750	

*1. The frame for PF-155E-W is aluminum.

*2. Value when the rated voltage is applied.

*3. The measuring method for the maximum air flow/maximum static pressure is the double-chamber method.

*4. The noise is measured in an anechoic room with low reverberation. Note that the noise figure is greatly affected by the local installation environment and reverberation.

- The expected lifetime is approx. 60,000 hours (approx. 6.8 years) for PF-091E-W and approx. 40,000 hours (approx. 4 and a half years) for PF-125E-W and PF-155E-W with continuous operation in the ambient temperature of 60°C and approx. 90,000 hours (approx. 10 years) for PF-091E-W and approx. 70,000 hours (approx. 8 years) for PF-125E-W and PF-155E-W with continuous operation in the ambient temperature of 40°C.

The expected lifetime for the ambient temperature of 40°C is for reference.

- The performance figure is for the fan alone.

[External dimensions diagram]

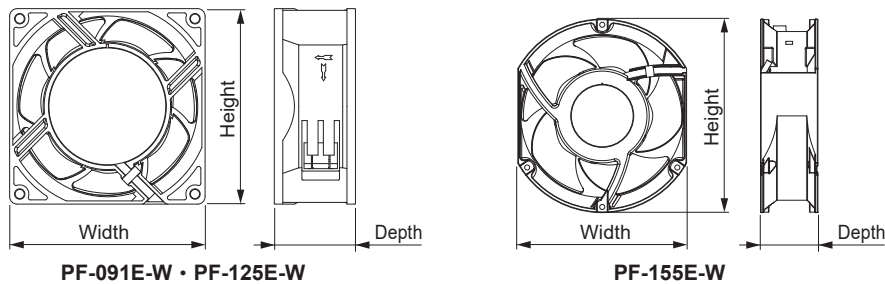

● Air flow - static pressure characteristics (reference figure)

Value when the rated voltage is applied.

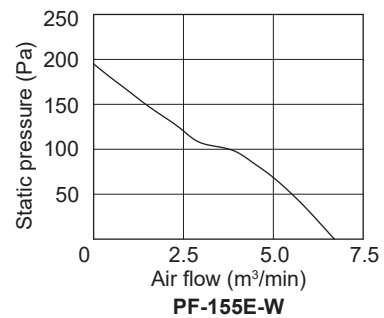
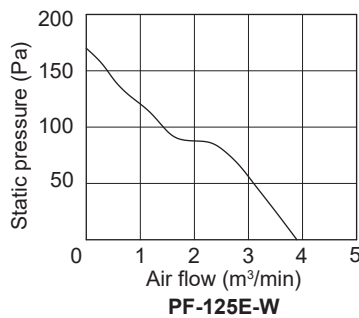
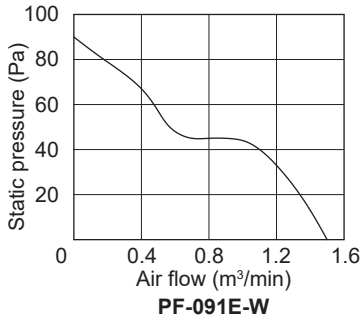

■ Mounting

- Mount the product on the enclosure that is to be used indoors.

Caution

- When mounting or performing maintenance and checkup at a high place, make sure that there is no one underneath. Dropping the product or parts may cause injuries.
 - When mounting or performing maintenance and checkup with live parts nearby, secure the live parts. Dropping the product or parts may cause short-circuits.
 - Check the mounting (airflow) direction. Otherwise, malfunction of the equipment inside the enclosure may result.
 - If using two or more units, mount them so that air does not interfere with each other by installing a divider or keeping two fans at a distance from each other.
- Also, secure a sufficient area for the intake port. Otherwise, it may lead to malfunction or incorrect startup.

Required area for intake port

Model	Required area for intake port cm ²
PF-091E-W	71
PF-125E-W	116
PF-155E-W	170

- We recommend that you secure at least the fan's external dimensions between the intake port/exhaust port and the obstacle so that the airflow for the intake port/exhaust port is not inhibited. (See page 4 "Proper usage")
- Mount the product in a place where maintenance and checkup can easily be performed.
- Mount the product on the enclosure with the proper thickness for mounting. The proper thickness for mounting is 0.8 to 4.5 mm. The proper thickness for mounting for PF-155E-W is 0.8 to 3.0 mm if installing a finger guard on both sides of the fan. If you wish to use the product with an enclosure with the thickness of more than 3.0 to 4.5 mm, use mounting screws with the length of at least M4 x 70.
- Mount the product at an altitude of maximum 2,000 m.

Caution Otherwise, performance deterioration or malfunction may result.

- We recommend using a fuse or circuit protector to protect the fan.

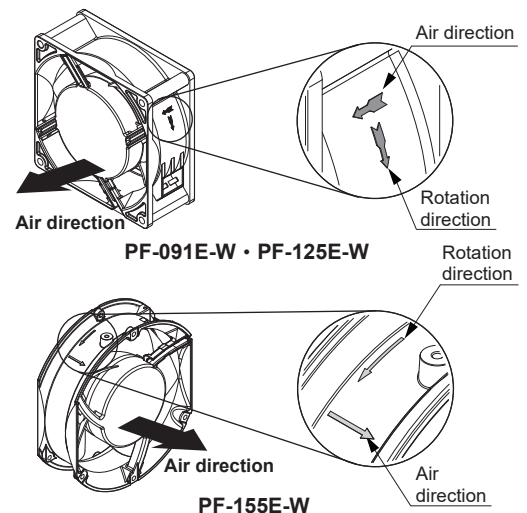

● Mounting method

1. Drill a cut-out hole in the enclosure. (See [Mounting diagram].)

Caution

- If any burring occurs on the mounting surface, make sure to remove the burr.
 - Be sure to correct the mounting surface with touch-up paint (our model number: BP81) or the like, after drilling cut-out holes. Otherwise, rust may occur.
2. Fix securely to the enclosure with the supplied mounting screws M4 x 55, M4 x 65, mounting nuts M4.

[Mounting diagram]

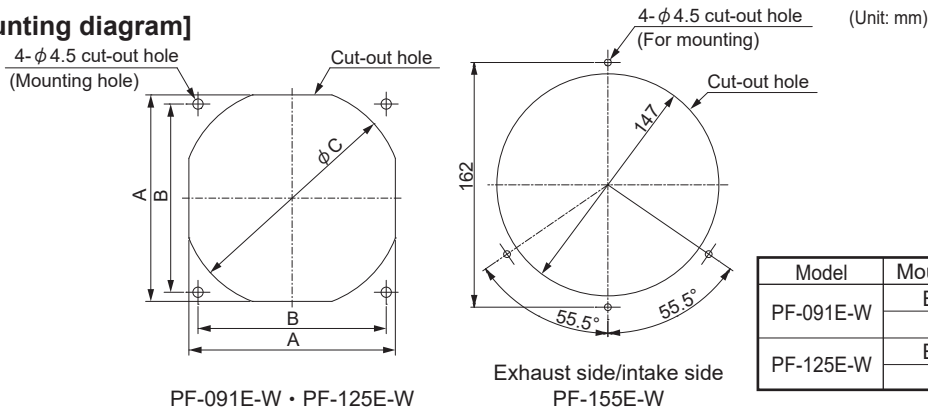

(Unit: mm)

Model	Mounting direction	A	B	C
PF-091E-W	Exhaust side	90.5	82.5	105
	Intake side			97
PF-125E-W	Exhaust side	118	105	122
	Intake side			116

■ Proper usage

- Install ventilation openings for intake or exhaust on the enclosure.

- If there is any obstacle near the exhaust port or intake port of the fan, it can significantly reduce the air flow and cause loud noises.

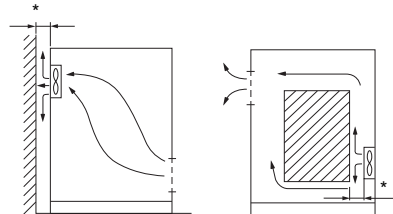
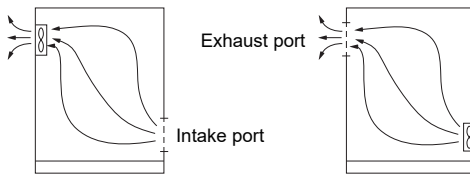

- If the air speed distribution of the enclosure becomes uneven due to the setup of the air path, it will cause local heating.

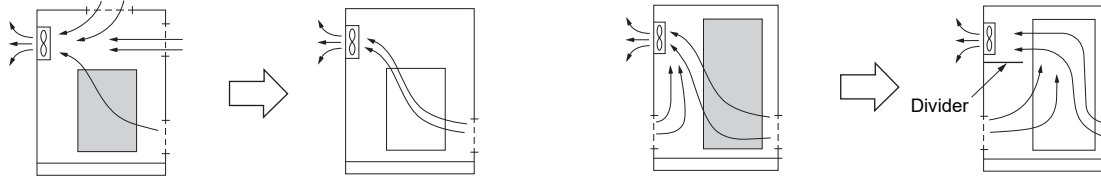

Caution

- If performing energy-saving operation, use the product in combination with a panel temperature controller and variable temperature controller. (See "■ Recommended items")
- The air direction and fan rotation direction are indicated on the side of the frame. (See page 3 "■ Mounting")

■ Recommended items

[Variable temperature controller]

Automatic operation in combination with a variable temperature controller allows appropriate temperature control within the enclosure, while achieving energy-saving operation at the same time. (Also use a panel temperature controller (such as PT-40A) with a fixed temperature.)

Model	External dimensions mm			Temperature rating			Contents of the set
	Width	Height	Depth	Setting range °C	ON/OFF temperature range K (°C)	Temperature tolerance K (°C)	
PTV-M61A	31	53	40	0 to 60	Approx. 7	±4	1 pc.

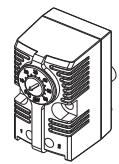

PTV-M61A

■ Before determining the product to be faulty

Check the following points again.

Content of problem	Action
Does not run	<ul style="list-style-type: none"> - If the power source is not supplied to the product, check the wiring connections and supply the power. - If the circuit breaker is off, turn on the circuit breaker. - Check if the fan blades come in contact with a foreign object and make sure that they are free from any contact. - If using two or more units, mount them so that air does not interfere with each other by installing a divider or keeping two fans at a distance from each other.
Insufficient cooling	<ul style="list-style-type: none"> - Remove any obstacles that may interfere with the ventilation of the intake and exhaust ports. - If the internal heating value or ambient temperature is higher than the selected conditions, the sufficient cooling capacity cannot be secured.

Technical Support Dept

If you have any question regarding contents of this document, please contact our technical support department.

TEL+81-561-64-0152

<Reception hours> 9:00~12:00, 13:00~17:00 (JST) (Closed on Saturdays, Sundays and holidays.)

Installation worker

TEL

Installation date D M Y

We are not responsible for any secondary damage caused by our company's foreseeability due to failure or defect of this product. Specifications etc. contained herein may be changed without notice.

April 2024

A

NITTO KOGYO

© NITTO KOGYO CORPORATION

NITTO KOGYO CORPORATION
2201 Kanihara, Nagakute-shi, Aichi